

**DAIKIN**

# WIRED REMOTE CONTROLLER

## INSTALLER REFERENCE GUIDE



BRC1E53

**Be sure to read these installation instructions before  
conducting the installation of this product.**

# Contents

1. Safety Precautions .....	2
2. Accessories .....	4
3. Remote controller installation procedure .....	4
4. Functions and menu items of the remote controller buttons .....	10
5. Power-on .....	12
6. Field settings .....	15
7. Test operation method (SkyAir only) .....	18
8. Checking procedure of Error History .....	22
9. Registration method of the Maintenance Contact information ...	23
10. Confirmation of registered details .....	24
11. Energy demand control .....	25
12. Clock & Calendar .....	27
13. Language .....	28
14. Prohibit Buttons .....	29
15. Function Prohibition .....	31
16. Prohibit Mode .....	32
17. Duty Rotation and Backup .....	34
18. External Input Interlock Function .....	37
19. Single and Dual setpoint mode .....	43
20. Other Service Settings .....	44
21. Software update with Updater .....	46
22. Connection diagram .....	47



# 1. Safety Precautions

The original instructions are written in English. All other languages are translations of the original instructions.

## ■ Also see the installation manual attached to the indoor unit.

**Please read these Safety Precautions carefully before installing the remote controller.**

- This manual classifies the precautions into WARNING and CAUTION. They both contain important information regarding safety. Be sure to follow all the precautions below.

 <b>WARNING</b>	Failure to follow these instructions properly may result in personal injury or loss of life.
 <b>CAUTION</b>	Failure to observe these instructions properly may result in property damage or personal injury, which may be serious depending on the circumstances.

- After completing the installation, conduct a trial operation to check for faults and explain to the customer how to operate the air conditioner with the aid of the operation manual. Ask the customer to store the installation and operation manual for future reference.

 <b>WARNING</b>	
Ask your dealer or qualified personnel to carry out installation work. Do not attempt to install the remote controller yourself. Improper installation may result in water leakage, electric shocks or fire.	
Consult your local dealer regarding relocation and reinstallation of the remote controller. Improper installation work may result in leakage, electric shocks or fire hazards.	
Install the remote controller in accordance with the instructions in this installation manual. Improper installation may result in water leakage, electric shocks or fire.	
Be sure to use only the specified accessories and parts for installation work. Failure to use the specified parts may result in the unit falling down, water leakage, electric shocks or fire.	
Install the remote controller on a foundation strong enough to withstand the weight of the remote controller. Insufficient strength may result in the remote controller falling down and causing injury.	
Electrical work must be performed in accordance with the relevant local and national regulations and with the instructions in this installation manual. Be sure to use a dedicated power supply circuit only. Insufficient power circuit capacity and improper workmanship may result in electric shocks or fire.	
Always perform installation work with the power turned off. Touching electric parts may result in electric shock.	
Do not disassemble, reconstruct or repair. This may result in electric shock and/or fire.	
Make sure that all wiring is secured, the specified wires are used and that there is no strain on the terminal connections or wires. Improper connections or securing of wires may result in abnormal heat build-up or fire.	
The choice of materials and installations must comply with the applicable national and international standards.	

 **CAUTION**

To avoid leakage and electric shock due to entry of water or insects, fill the wiring through hole with putty.

To avoid electric shocks, do not operate with wet hands.

Do not wash the remote controller with water, as this may result in electric shocks or fire.

Install the indoor and outdoor units, power cord and connection wires at least 1 meter away from televisions or radios to prevent interference and noise.  
(Depending on the incoming signal strength, a distance of 1 meter may not be sufficient to eliminate noise.)

Do not install the air conditioner in the following locations:





1. Where there is a high concentration of mineral oil spray or vapour (e.g. a kitchen).  
Plastic parts may deteriorate and fall off which could result in water leakage.
2. Where corrosive gas, such as sulphurous acid gas, is produced.  
Corroding of copper pipes or soldered parts may result in refrigerant leakage.
3. Near machinery emitting electromagnetic radiation.  
Electromagnetic radiation may disturb the operation of the control system and result in malfunctioning of the unit.
4. Where flammable gas may leak, where there is carbon fibre or ignitable dust suspensions in the air or where volatile flammables such as paint thinner or gasoline are handled.  
Operating the unit in such conditions may result in fire.
5. High temperature areas or direct flames.  
Overheating and/or fire may occur.
6. Moist areas or places which may be exposed to water.  
If water enters the remote controller, electric shock may be caused and the inner electronics may fail.

When the thermostat function of the remote controller is used, select the installation location while considering it should be a place:

- Where the average temperature in the room can be detected.
- Which is not exposed to direct sunlight.
- Which is not near a heat source.
- Which is not affected by the outside air or air draught due to, for example, opening/closing of doors, the air outlet of the indoor unit or the like.

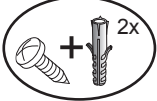
## 2. Accessories

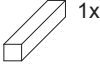
The following accessories are included.

Wood screw + wall plugs ( $\varnothing 4.0 \times 30$ ) 	Small screw (M4 $\times$ 16) 	Clamp 	Wiring retainer 	Installation and operation manual 
	2x	1x	1x	7x

## 3. Remote controller installation procedure

### 3-1 Determine where to install the remote controller.

Make sure to follow "1. Safety Precautions" when determining the location.

### 3-2 Make a wiring through hole on the wall if the wires are coming out from the rear.

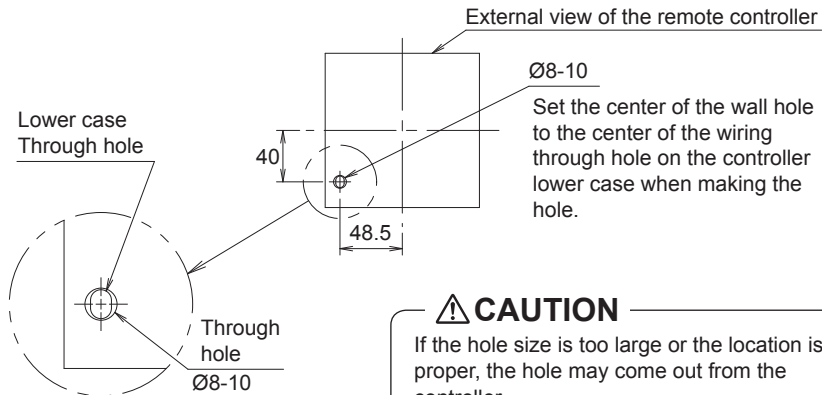

### 3-3 Determine the direction of the controller wiring outlet (rear outlet, left outlet, top left outlet, top center outlet).

#### 3-3-1 Rear outlet

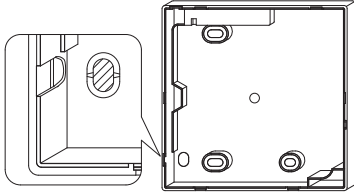

Cut off the resin area (hatched area).

#### 3-3-2 Left outlet

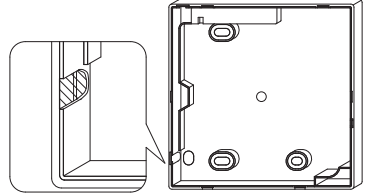

Cut off the thin area (hatched area) with nippers or the like and then remove the burrs with a file or the like.

#### 3-3-3 Top left outlet

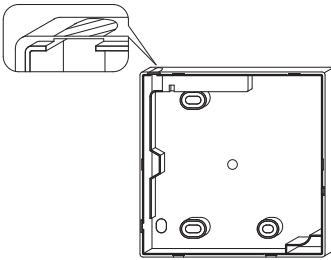

Cut off the thin area (hatched area) with nippers or the like and then remove the burrs with a file or the like.

#### 3-3-4 Top center outlet

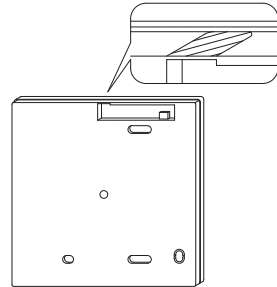

Cut off the thin area (hatched area) with nippers or the like and then remove the burrs with a file or the like.

### 3-4 Conduct wiring.

#### **⚠ CAUTION**

1. The switchbox and the transmission wiring should not be attached.
2. Do not directly touch the remote controller PCB.

#### Wiring Specifications

Wiring Type	Sheathed vinyl cord or cable
Wiring Size	0.75~1.25 mm <sup>2</sup>
Wiring Length	Max. 500 m <sup>(*)</sup>

\*This is the total length in the system when using group control.

The sheath part in the remote controller case should be stripped following these instructions.

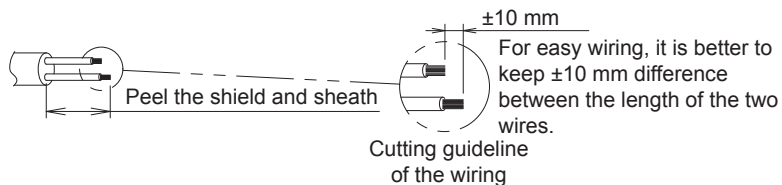

Sheath stripping length:

- $\pm 150$  mm for top left outlet
- $\pm 200$  mm for top center outlet

Connect the terminals (P/P1, N/P2) of the remote controller to the terminals (P1, P2) of the indoor unit. (P1 and P2 have no polarities.)

### 3-4-1 Rear outlet

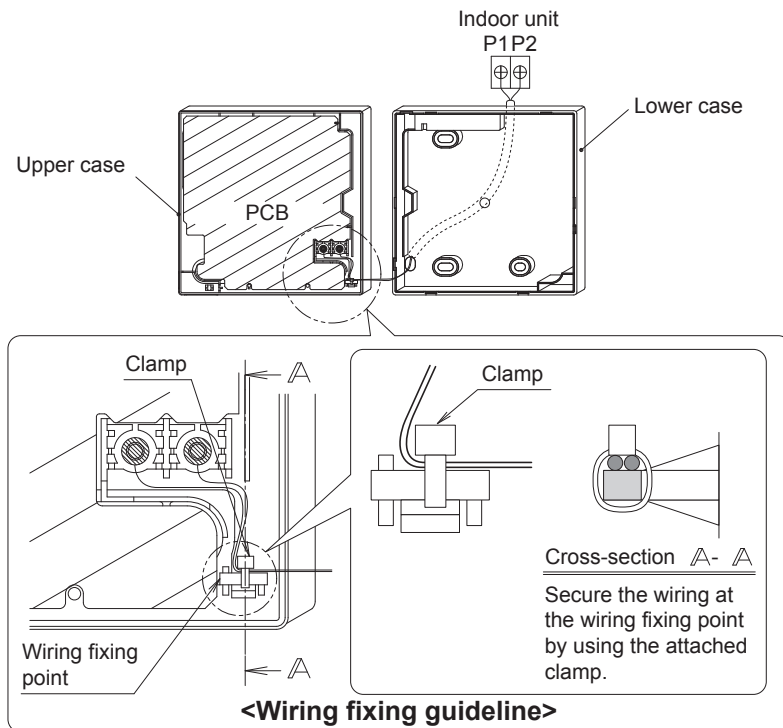

### 3-4-2 Left outlet

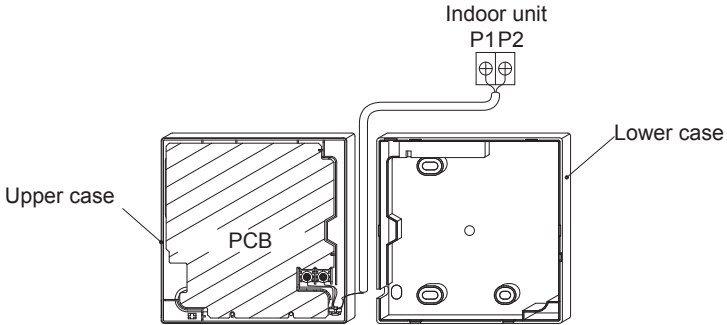

### 3-4-3 Top left outlet

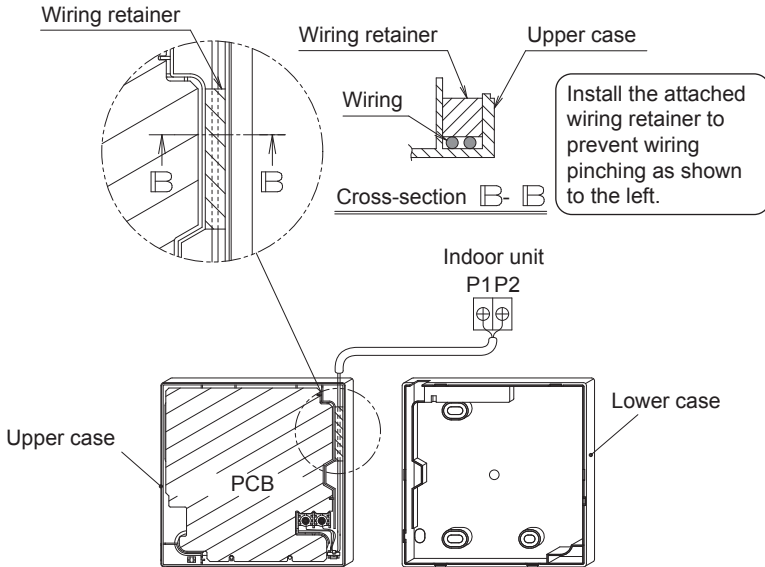

### 3-4-4 Upper center outlet

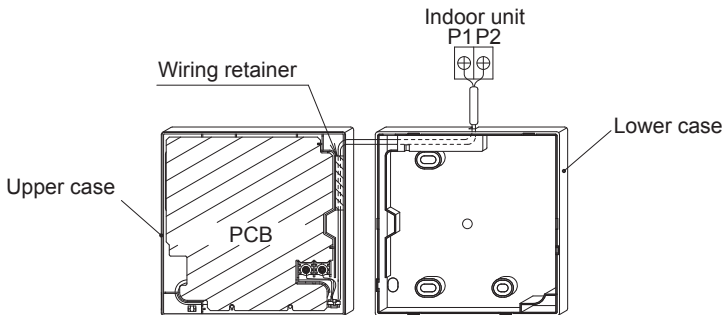



**⚠ CAUTION**

- Do not perform wiring close to a power line in order to avoid electrical noise (external noise).
- Seal the wiring draw-in port securely with putty (field supply) to prevent the entry of insects or the like.

**3-5 Fixing procedure of the lower case.**

In the case of wiring a remote controller through the top center outlet or rear outlet, perform the wiring through the outlet hole in the lower case before it is installed on the wall.

**3-5-1 Wall mounting**

Secure by using the attached wood screws (2×).

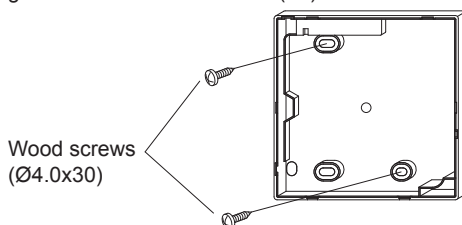
**3-5-2 Switchbox mounting**

Secure by using the attached small screws (2×).

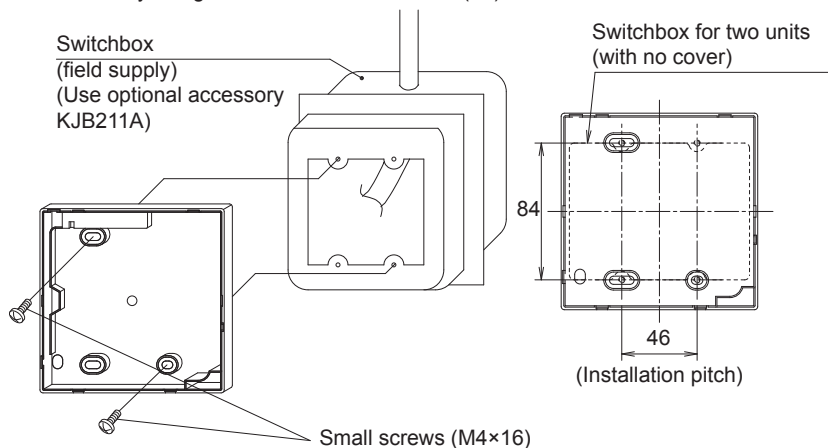

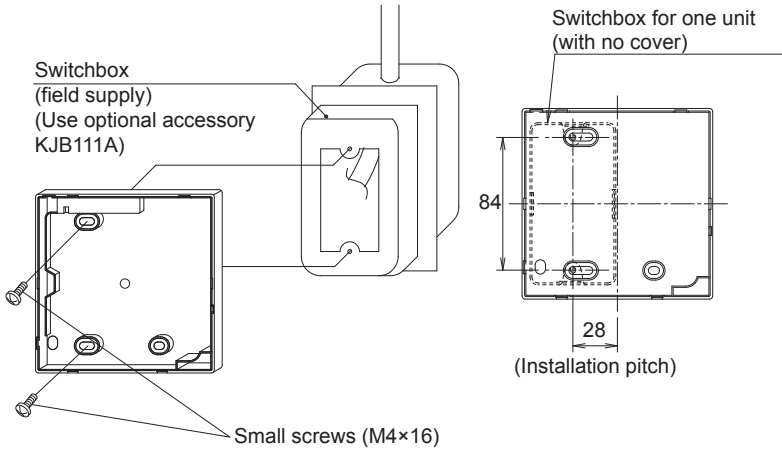

**CAUTION**

- Select a flat surface for installation if possible.
- Do not tighten the installation screws too much to avoid deforming the lower case.

**3-6 Attach the upper case.**

- Align the upper case with the tabs of the lower case (6 points) and insert the upper case.
- Be careful not to pinch the wiring when attaching.
- Peel off the protective seal which is attached to the upper case.

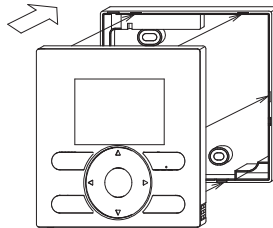

**3-7 Remove the upper case.**

Insert a slot screwdriver into the slots in the lower case (2 places) to remove the upper case.

**NOTE**

- The remote controller PCB is installed on the upper case. Be careful not to damage the PCB with the slot screwdriver.
- Take care that dust or moisture does not touch the PCB of the removed upper case.

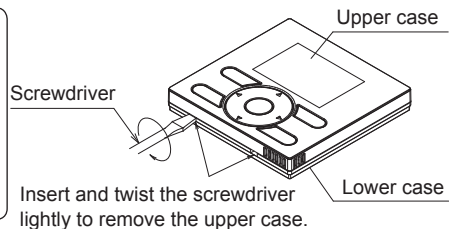

# 4. Functions and menu items of the remote controller buttons

## 4-1 Functions and menu items

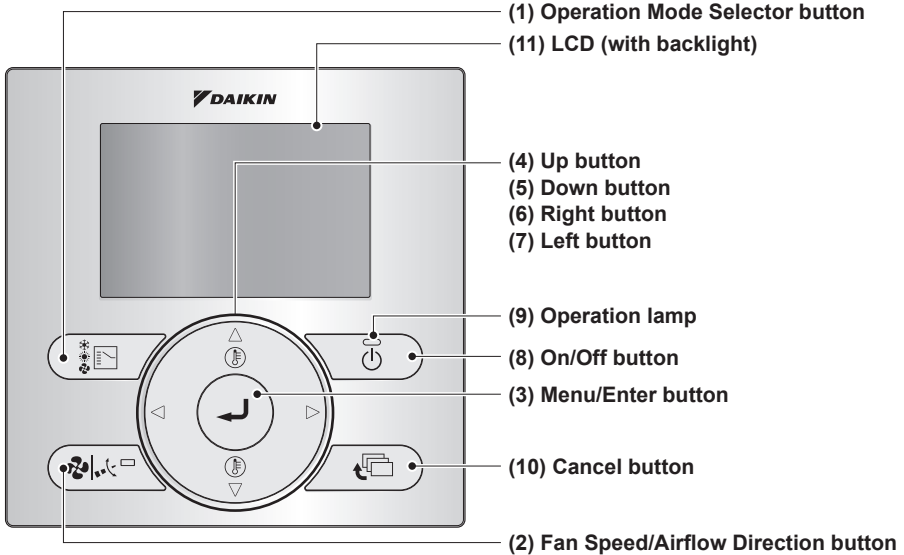

- (1) Operation Mode Selector button**
  - Press this button to select the operation mode of your preference.
  - Available modes may vary with the connected model.
- (2) Fan Speed/Airflow Direction button**
  - Used to change the fan speed and airflow direction.
  - Available fan speeds may vary with the connected model.
- (3) Menu/Enter button**
  - Used to display the main menu or enter the selected item. (For details on the main menu, see the operation manual.)

### Main menu\*

Lock Function\*\*  
 Rotation\*\*  
 Airflow Direction  
 Individual Air Direction  
 Quick Start  
 Ventilation  
 Energy Saving Options  
 Schedule  
 Filter Auto Clean  
 Maintenance Information  
 Configuration  
 Current Settings  
 Clock & Calendar  
 Language

\* Available menu items are depending on the connected model.

\*\*Lock Function and Rotation are hidden menu items. For instructions on how to make them visible, refer to chapters 14, 15, 16, and 17.

**(4) Up button ▲**

- Used to raise the set temperature.
- The next item on the upper side will be highlighted.  
(Keep pressing the button to cycle through the values or items.)
- Used to change the selected item.

**(5) Down button ▼**

- Used to lower the set temperature.
- The next item on the lower side will be highlighted.  
(Keep pressing the button to cycle through the values or items.)
- Used to change the selected item.

**(6) Right button ►**

- Used to highlight the next item on the right-hand side.
- The display contents are changed to the next screen.

**(7) Left button ◀**

- Used to highlight the next items on the left-hand side.
- The display contents are changed to the previous screen.

**(8) On/Off button**

- Press to start or stop the air conditioner.

**(9) Operation lamp (Green)**

- This lamp lights up during operation.
- This lamp will blink if an error occurs.
- This lamp is not lit when the unit operation is OFF.

**(10) Cancel button**

- Used to return to the previous screen.
- Press and hold this button for 4 seconds or longer to display the Service Settings menu.

**(11) LCD (with backlight)**

- The backlight will be lit for approximately 30 seconds when one of the buttons is pressed.
- The actions linked to the buttons, except for the On/Off button, are not carried out when the backlight is not lit.
- When two remote controllers are used to control a single indoor unit, the backlight of the remote controller which is operated first will be lit.
- The Auto Display Off function allows for the display to turn off automatically after a set period of time. For instructions on how to set and enable Auto Display Off, refer to the user reference guide.

**Service Settings menu\***

- Test Operation
- Maintenance Contact
- Field Settings
- Demand
- Min Setpoints Differential
- External Input Interlock
- Group Address
- Indoor unit Airnet Address
- Outdoor unit Airnet Address
- Error History
- Indoor Unit Status
- Outdoor Unit Status
- Forced Fan ON
- Switch Main Sub Controller
- Filter Indicator
- Test Filter Auto Clean
- Brush/Filter Ind
- Disable Filter Auto Clean

\*Available menu items are depending on the connected model.

**4-2 Description of button operation**

**<Service Settings>**

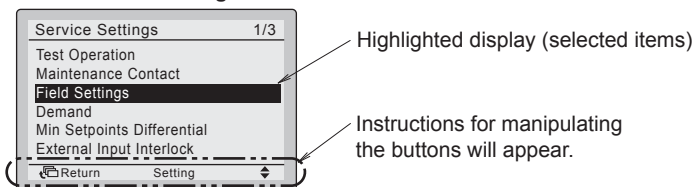

## 5. Power-on

### ⚠ CAUTION

- It is not possible to use two remote controllers and the Digital Input Adapter BRP7A\* together. The Digital Input Adapter will not work and will be in an error state when a sub remote controller is detected.
- When controlling one indoor unit with two remote controllers, one remote controller needs to be set as the main remote controller and one as the sub remote controller. This selection needs to be made once during start up and can be changed afterwards in the Service Settings menu.

- Check that the indoor/outdoor unit wiring is completed.
- Check that the switchbox cover of the indoor and outdoor units are closed before powering on.

### If one indoor unit is controlled by a remote controller

**5-1** Turn on the power.

**5-2** "Checking the connection. Please stand by." is displayed.

<Main remote controller>

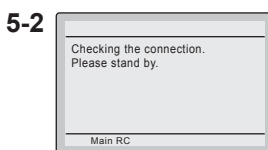

### NOTE

When the text on the left is displayed, the backlight does not light up when one of the buttons is pressed.



<Basic screen>

**5-3** The Basic screen is displayed.

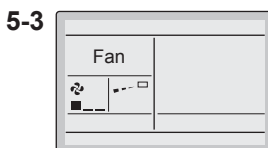

### If one indoor unit is controlled by 2 remote controllers

**5-4** Put on the power.

**5-5** "Checking the connection. Please stand by." is displayed.

<Main remote controller>

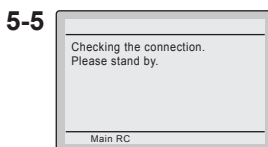

<Sub remote controller>

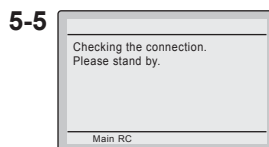

### NOTE

When the above text is displayed, the backlight does not light up when one of the buttons is pressed.

**5-6** If the sub remote controller is not set when powering on when one indoor unit is controlled by two remote controllers, "Error code U5" is displayed in the connection checking screen.

**5-6**

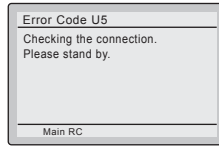

**5-6**

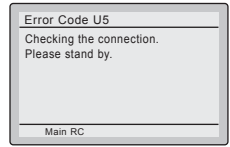

**5-7**

**5-7** Select the sub remote controller by pressing the Operation Mode Selector button of either one of the remote controllers for 4 seconds or longer.



Press and hold the Operation mode selector button of the sub remote controller for 4 seconds or longer.

**5-8** When the display is changed from Main RC to Sub RC, the setting is completed

**5-8**

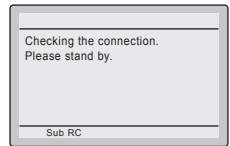

**NOTE**

If the Basic screen is not displayed more than 2 minutes after the "Sub RC" display, turn off the power and check the wiring.

**5-9** The Basic screen is displayed.

**5-9**

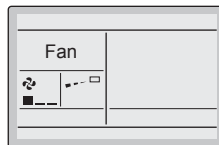

**5-9**

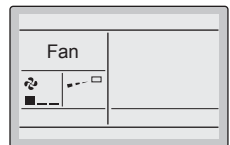

**CAUTION**

It's only possible to use a main and a sub remote controller of the same type. For example, do not combine BRC1E52\* with BRC1E53\*.

**NOTE**

- When selecting a different language, refer to "[13. Language](#)" on page 28.
- The following functions cannot be set in the sub remote controller.  
Set them in the main remote controller:
  - Individual Airflow Direction
  - "Auto" operation mode (switches to cooling or heating)
  - Energy Saving Options
  - Schedule
  - Service Settings (only Test Operation, Maintenance Contact and Switch Main Sub Controller are available).
  - Demand
  - Quiet Operation Mode
  - Rotation
  - Draft Prevention

# 6. Field settings

**6-1** Press and hold the Cancel button for 4 seconds or longer. The Service Settings menu is displayed.

**<Basic screen>**

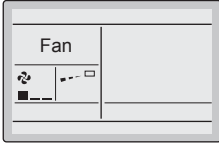





Press and hold the Cancel button for 4 seconds or longer while the backlight is lit.

**6-2** Select **Field Settings** and press the Menu/Enter button.

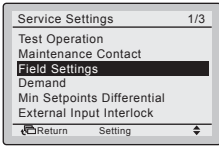
**<Service Settings>**





Press the Menu/Enter button.

**6-3** "Highlight the "Mode No." by using the ◀▶ (Left/Right) buttons., and select the desired "Mode No." by using the ▲▼ (Up/Down) buttons. For the most commonly-used field settings, refer to page 17.

**<Field settings>**

**In the case of individual setting per indoor unit**

**In the case of group setting**

**6-4** In the case of configuring the indoor units individually during group control (When Mode No. such as 20, 21, 22, 23, 25 are selected), highlight the unit No. by using the ◀▶ (Left/Right) buttons. and select the "Indoor unit Number" to be set by using the ▲▼ (Up/Down) buttons. (In the case of configuring as a group, this operation is not needed.)

**6-3**

**6-4**

**6-5**

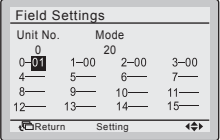

**6-4**

**6-6**

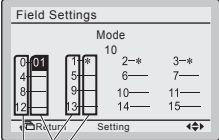

SECOND CODE NO.  
FIRST CODE (SW) NO.

## NOTE

- In the case of individual configuration per indoor unit, the current settings are displayed.
- SECOND CODE NO. " - " means that there is no function available
- In the case of configuring as a group, all SECOND CODE NO. which may be set are displayed as " \* "

**6-5** Highlight the SECOND CODE NO. of the FIRST CODE NO. to be changed by using the ◀▶ (Left/Right) buttons and select the desired SECOND CODE NO. by using the ▲▼ (Up/Down) buttons. Multiple identical mode number settings are available.



Press the Menu/Enter button.



**6-6** Press the Menu/Enter button. The confirmation screen is displayed. **6-6**

**6-7** Select **Yes** and press the Menu/Enter button. The settings are saved and the Field settings screen returns.

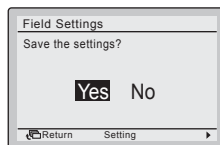

Press the Menu/Enter button.



<Field Settings>

**6-8** When multiple settings need to be changed, repeat "6-2" to "6-7".

**6-9** After all changes are completed, press the Cancel button twice.

**6-10** The backlight goes out and "Checking the connection. Please stand by" is displayed during initialization. After the initialization, the Basic screen returns.

### ⚠ CAUTION

- When an optional accessory is installed on the indoor unit, the settings of the indoor unit may be changed. See the manual of the optional accessory.
- For the details on the field settings of the indoor unit, see the installation manual attached to the indoor unit.
- The outdoor unit field settings can only be configured on the outdoor PCB. Refer to the installation manual attached to the outdoor unit.

### NOTE

- Though the configuration is performed for the whole group, set the Mode No. in parenthesis when performing an individual configuration per indoor unit or when checking after the configuration is finished.
- The SECOND CODE NO. at factory shipment depends on the indoor unit model. Default values can be found in the respective Service Manual of the respective units. For the following settings, the value is the same for all indoor units.
  - Thermostat sensor used for the "Auto" operation mode and the Setback function (room temperature on detailed display): "02".
  - Setback function: "04"
  - External input B1: "02"
  - External input B2: "02"
  - Airflow direction range (except roundflow cassette): "02"
  - Thermostat sensor in remote controller (Sky Air only): "02"
  - Rotation overlap time: "03"
- Functions which are unavailable for the connected indoor unit(s) are not displayed.

Mode No. (Note 1)	FIRST CODE NO.	Description of the setting		SECOND CODE NO. (Note 2)					
				01	02	03	04		
10 (20)	0	Filter Contamination - Heavy/Light Setting for when "Time to clean the air filter" icon is shown (when filter contamination is heavy the time to clean the air filter is to be halved).	Ultra long life filter	Light	±10.000 hrs.	Heavy	±5.000 hrs.	—	—
			Long life filter		±2.500 hrs.		±1.250 hrs.		
			Standard filter		±200 hrs.		±100 hrs.		
	1	Long-life filter type (setting of the filter sign indication time). (Change setting when a ultra-long filter is installed).	Long-life filter	Ultra-long life filter	—	—			
2	Thermostat sensor in the remote controller.	Use combined (with indoor thermistor)	Do not use	Use exclusively	—				
3	Setting for when the filter sign is not to be displayed.	Display	Do not display	—	—				
11 (21)	0	Number of connected SkyAir simultaneous operation indoor units (setting for simultaneous operation system).	Pair	Twin	Triple	Double twin			
12 (22)	1	External On/Off input from outside (setting for when forced On/Off is to be operated from somewhere else).	Forced OFF	On/Off operation	Emergency	Forced OFF			
	2	Thermostat differential changeover (setting for when using a remote sensor).	1°C	0.5°C	—	—			
13 (23)	0	High air outlet velocity (for high ceiling applications).	$h \leq 2.7$ m	$2.7$ m < $h \leq 3.0$ m	$3.0$ m < $h \leq 3.5$ m	—			
	1	Selection of airflow direction (setting for when a kit has been installed that blocks the airflow).	4-way flow	3-way flow	2-way flow	—			
	3	Selection of airflow function (setting for when using a decoration panel at the outlet).	Equipped	Not equipped	—	—			
	4	Airflow direction range setting.	Upper	Normal	Lower	—			
	6	The external static pressure setting (setting according to the connected duct resistance).	Normal	High static pressure	Low static pressure	—			
FHYK: follow the high ceiling setting.		Normal	High ceiling	—	—				
15 (25)	3	Drain pump operation with humidifying.	Equipped	Not equipped	—	—			
1c	1	Thermostat sensor used for the "Auto" operation mode and the Setback function (room temperature on detailed display).	Indoor thermistor (intake temperature)	Remote controller thermistor	—	—			
1c	12	External input B1.	Do not use	Use	—	—			
1c	13	External input B2.	Do not use	Use	—	—			
1e	2	Setback function.	Do not use	Heat only	Cool only	Cool and Heat			
1e	7	Rotation overlap time.	30 minutes	15 minutes	10 minutes	5 minutes			

# 7. Test operation method (SkyAir only)

\* In the case of VRV, see the manual attached to the outdoor unit.

**Also see the installation manuals attached to the indoor unit and the outdoor unit.**

- Check that the wiring of the indoor unit and the outdoor unit is completed.
- Check that the switchbox cover of the indoor unit and the outdoor unit is closed.
- After refrigerant piping, drain piping and electric wiring are completed, clean the inside of the indoor unit and the decorative panel.
- Perform the test operation according to the following procedure.

## NOTE

- The backlight will be lit for approximately 30 seconds when pressing one of the operation buttons.
- Operate the buttons only when the backlight is lit. However, the On/Off button can be operated when the backlight is not lit.

- 7-1** Make sure to turn on the power at least 6 hours before starting test operation to protect the compressor.

## CAUTION

Make sure that the outer panel and piping cover are closed before operation (danger of electric shock).

- 7-2** Confirm that both the liquid and gas stop valves are opened.

## NOTE

After the air purge of the vacuum pump, the refrigerant pressure may not rise even though the stop valve is opened. The reason is that the refrigerant system of the outdoor unit is blocked by the electrical expansion valve or the like. Operation is no problem.

- 7-3** Set the operation mode to cooling by using the Operation Mode Selector button.

- 7-4** Press and hold the Cancel button for 4 seconds or longer. The Service Settings menu is displayed.

**7-3**

**7-4**

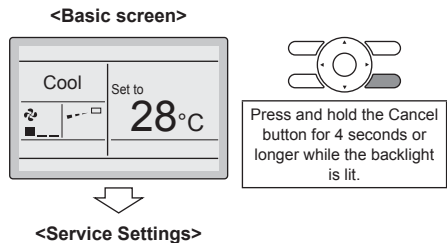

**7-5** Select **Test Operation** and press the Menu/Enter button. The Basic screen returns and "Test operation" is displayed.

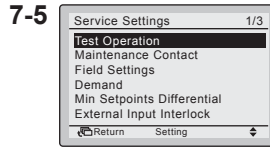

Press the Menu/Enter button.

**7-6** Press the On/Off button within about 10 seconds. Test operation starts. Check the operation condition for 3 minutes.

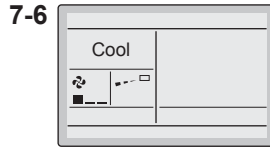

Press the On/Off button (within 10 seconds).

**NOTE**

Test operation can also be started by first performing 7-6 followed by 7-5.



Press the Menu/Enter button.

**7-7** Press the Fan Speed/Airflow Direction button

<Main menu>

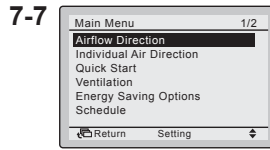

Press the fan speed/airflow direction button

**7-8** Press the ► button to select the airflow direction setting. Use the ▲▼ buttons to change the airflow direction.

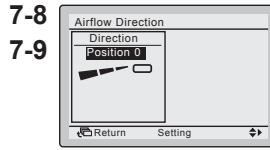

To select the airflow direction setting, press the ► (Right) button on the setting screen

**7-9** After confirming correct airflow operation, press the Menu/Enter button to return to the Basic screen

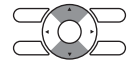

Change the airflow direction by using the ▲▼ (Up/Down) buttons.



Press the Menu/Enter button.

**7-10** Press and hold the Cancel button for 4 seconds or longer in the Basic screen. The Service Settings menu is displayed.

**7-10**

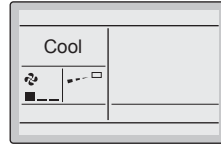

Press and hold the Cancel button for 4 seconds or longer while the backlight is lit.



<Service Settings menu>

**7-11** Select **Test Operation** in the Service Settings menu and press the Menu/Enter button. The Basic screen returns and normal operation is possible.

**7-11**

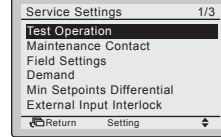

Press the Menu/Enter button.



<Basic screen>

**7-12** Check the functions according to the operation manual.

**7-13** When the decoration panel is not installed, turn off the power after test operation finishes.

## NOTE

Test operation will automatically finish after 30 minutes.

## CAUTION

- If the interior work is not completed when the test operation is finished, explain to the customer that he should not operate the unit until the interior work is completed in order to protect the indoor unit.
- (If the indoor unit is operated, the indoor unit may be contaminated with the materials which arise from paints or adhesives during the interior work and water splash or water leak may occur.)

## CAUTION

- If it is not possible to operate the unit due to any malfunction, refer to **Malfunction diagnosis method**.
- When the test operation finishes, check that the error code history is not displayed in the Maintenance Information screen according to the following procedure.

**7-14** Press the Menu/Enter button in the Basic screen. The Main menu is displayed.

**7-14**

<Basic screen>

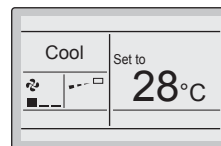

Press the Menu/Enter button.



<Main menu>

**7-15** Select **Maintenance Information** and press the Menu/Enter button.

**7-15**

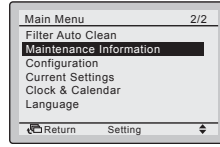

Press the Menu/Enter button.

**7-16** The Maintenance Information screen is displayed. Check that the last error code is not displayed in the screen.

**7-16**

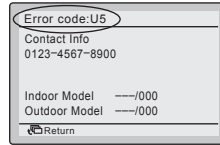

Press and hold the On/Off button for 4 seconds or longer.

**7-17** If the last error code is displayed, conduct the malfunction diagnosis referring to "Error code list" in the installation manual of the indoor unit. After the malfunction diagnosis finishes, press and hold the On/Off button for 4 seconds or longer in the "Maintenance Information" screen to erase the error code history.

### NOTE

If no error code is displayed when this procedure is followed, the system has completed the test operation normally.

### Malfunction diagnosis method

- When the remote controller displays any item in the following table, inspect the details in the table.
- If an error occurs, "▲" is displayed. Conduct the malfunction analysis referring to "Error code list" in the installation manual of the indoor unit. When the unit No. which detected the error during group control is confirmed, refer to "8. Checking procedure of Error History".

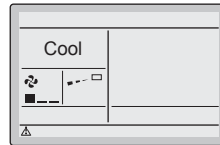

Remote controller display	Description
No display	<ul style="list-style-type: none"> <li>• Power outage, power voltage failure or open-phase</li> <li>• Wrong wiring (between indoor and outdoor units)</li> <li>• Indoor PCB assembly failure</li> <li>• Remote controller wiring disconnection</li> <li>• Remote controller failure</li> <li>• Blown fuse (outdoor unit)</li> <li>• The display is off because of the Auto Display Off function. For more information, refer to the user reference guide.</li> </ul>
Display "Checking the connection Please stand by" is shown.*	<ul style="list-style-type: none"> <li>• Indoor PCB assembly failure</li> <li>• Wrong wiring (between indoor and outdoor units)</li> </ul>

\* Though "Checking the connection Please stand by" is displayed for up to 90 seconds after powering on, this does not mean there is a failure. (Determine after 90 seconds.)

# 8. Checking procedure of Error History

**8-1** Press and hold the Cancel button for 4 seconds or longer in the Basic screen. The Service Settings menu is displayed.

<Basic screen>

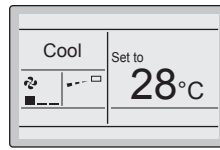

Press and hold the Cancel button for 4 seconds or longer while the backlight is lit.

**8-2** Select **Error History** and press the Menu/Enter button. The Error History menu is displayed.

<Service Settings>

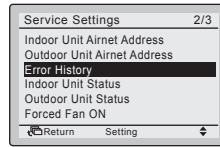

Press the Menu/Enter button.

**8-3** Select **RC Error History** and press the Menu/Enter button. The error codes and unit No. can be confirmed in the RC Error History screen.

**8-3**

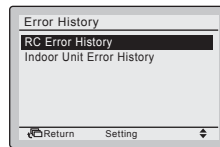

Press the Menu/Enter button.

**8-4** In the RC Error History screen the last 10 items are displayed in order.

**8-4**

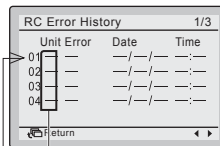

**8-5** Press the Cancel button in the RC Error History screen 3 times. The Basic screen returns.

**8-5**

Unit No.  
Latest record

## NOTE

In the Indoor Unit Error History the error history of each indoor unit can be independently consulted. The last 5 items are displayed in order.

# 9. Registration method of the Maintenance Contact information

- Registration of the service contact information.

**9-1** Press and hold the Cancel button for 4 seconds or longer in the Basic screen. The Service Settings menu is displayed.

**9-2** Select **Maintenance Contact** and press the Menu/Enter button. The "Maintenance Contact" screen is displayed.

**9-3** Select **Maintenance Contact** and press the Menu/Enter button.

**9-4** Enter the telephone number by using the ▲▼ (Up/Down) buttons. Use the ◀▶ (Left/Right) buttons to highlight the previous/next item. Blank items should be left as " - ".

**9-5** Press the Menu/Enter button. The setting confirmation screen is displayed.

**9-6** Select **Yes** and press the Menu/Enter button. The settings are entered and the Service Settings menu returns.

**9-7** Press the Cancel button once. The Basic screen returns.

**9-1** **<Basic screen>**

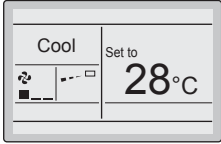

Press and hold the Cancel button for 4 seconds or longer while backlight is lit.

**9-2** **<Service Settings>**

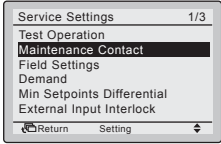

Press the Menu/Enter button.

**9-3**

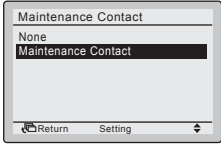

Press the Menu/Enter button.

**9-4**



**9-5**

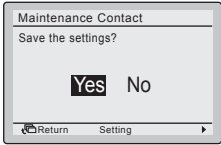

Press the Menu/Enter button.



**<Service Settings>**



# 10. Confirmation of registered details

**10-1** Press the Menu/Enter button in the Basic screen. The Main menu is displayed.

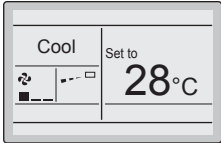

**10-1** **<Basic screen>**

Press the Menu/Enter button.

**10-2** Select **Maintenance Information** and press the Menu/Enter button. The "Maintenance Information" screen is displayed.

**10-2** **<Main menu>**

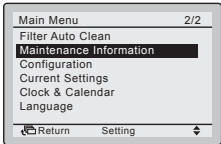
Press the Menu/Enter button.

**10-3** Confirm that the contact information is entered correctly.

**10-3** **Maintenance Information**

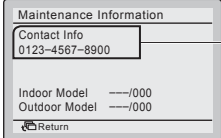

The registered details are displayed.



**10-4** Press the Cancel button twice. The Basic screen returns.

# 11. Energy demand control

- The Demand function allows you to set a timespan in which the system will consume less energy. The maximum power consumption can be reduced to 70% or 40%.

**11-1** Press and hold the Cancel button for 4 seconds or longer. The Service Settings menu is displayed.

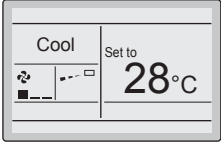

**11-1** **<Basic screen>**

Press and hold the Cancel button for 4 seconds or longer while the backlight is lit.

**11-2** Select **Demand** and press the Menu/Enter button. The Demand menu is displayed.

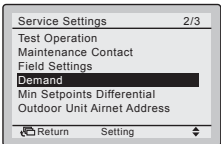

**11-2** **<Service Settings>**

Press the Menu/Enter button.

**11-3** Select **Settings** and press the Menu/Enter button. The "Demand" screen is displayed.

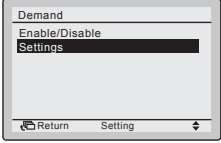

**11-3**

Press the Menu/Enter button.

**11-4** Press ▲▼ (Up/Down) buttons to make changes to the settings. Press the ◀▶ (Left/Right) buttons to move the highlighted item.

**11-4**

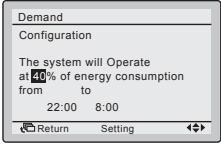
Press the Menu/Enter button.



**11-5** Press the Menu/Enter button. The confirmation screen is displayed.

**11-5**

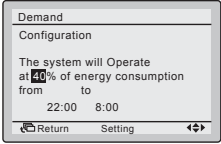

**11-6** Select **Yes** and press the Menu/Enter button. The settings are entered and the Basic screen returns.

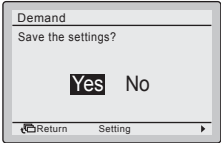

**11-6**

Press the Menu/Enter button.

**11-7** To enable/disable Demand, go to the Demand menu and select **Enable/Disable**

**11-7**

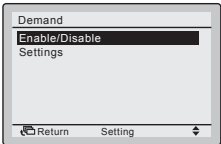
Press the Menu/Enter button.

**11-8** Press the ▲▼ (Up/ Down) buttons to select **Enable** or **Disable**. The confirmation screen will appear when the Menu/Enter button is pressed.

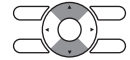
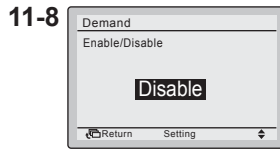

Change the setting by using the ▲▼ (Up/Down) buttons.

**11-9** Select **Yes** and press the Menu/Enter button. The function is enabled/ disabled and the Basic screen returns.

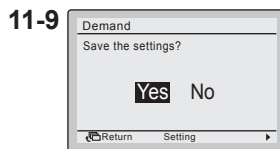

Press the Menu/Enter button.

## NOTE

- After saving changes to the settings, Demand is automatically enabled.
- The availability of the Demand function depends on the outdoor unit model.
- For Demand to be visible among the service settings, the clock needs to be set.

# 12. Clock & Calendar

**12-1** Press the Menu/Enter button in the Basic screen. The Main menu is displayed.

**<Basic screen>**

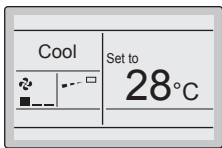



Press the Menu/Enter button.

**12-2** Select **Clock & Calendar** and press the Menu/Enter button. The "Clock & Calendar" menu is displayed.

**<Main menu>**

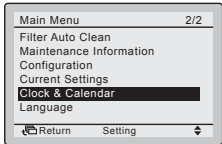

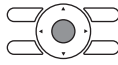

Press the Menu/Enter button.

**12-3** Select **Date & Time** and press the Menu/Enter button. The "Date & Time" screen is displayed.

**12-3**







Press the Menu/Enter button.

**12-4** Select the "Year", "Month", "Day" and time by using the ◀▶ (Left/Right) buttons and change the value by using the ▲▼ (Up/Down) buttons. When the buttons are pressed and held, the values change continuously.

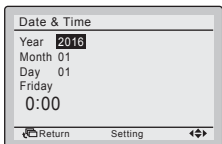
**12-4**





Press the Menu/Enter button.

**12-5** Press the Menu/Enter button. The confirmation screen is displayed.

**NOTE**

The day of the week is set automatically.

**12-6** Select **Yes** and press the Menu/Enter button. The settings are confirmed and the Basic screen returns.

**12-6**

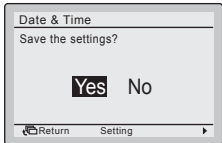

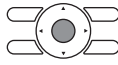

Press the Menu/Enter button.

**<Basic screen>**

**NOTE**

If a power outage lasts longer than 48 hours, the time is reset and needs to be set again.

# 13. Language

**13-1** Press the Menu/Enter button in the Basic screen. The Main menu is displayed.

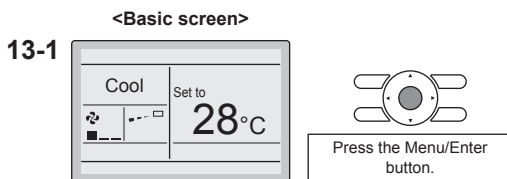

**13-2** Select **Language** and press the Menu/Enter button. The "Language" screen is displayed.

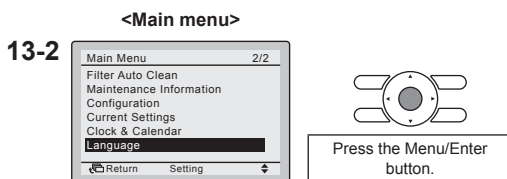

**13-3** Press the ▲▼ (Up/Down) buttons to select the desired language and press the Menu/Enter button. The settings are confirmed and the Basic screen returns.

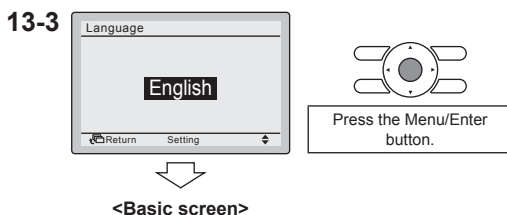

The visible languages vary by controller model.

BRC1E53A7		BRC1E53B7		BRC1E53C7	
7 Languages		7 Languages		7 Languages	
1) EN	English	1) EN	English	1) EN	English
2) DE	German	2) CZ	Czech	2) RU	Russian
3) FR	French	3) HR	Croatian	3) EL	Greek
4) IT	Italian	4) HU	Hungarian	4) TR	Turkish
5) ES	Spanish	5) SL	Slovenian	5) PL	Polish
6) PT	Portuguese	6) RO	Romanian	6) SQ	Albanian
7) NL	Dutch	7) BG	Bulgarian	7) SK	Slovak

# 14. Prohibit Buttons

- Restriction of the number of operable buttons.

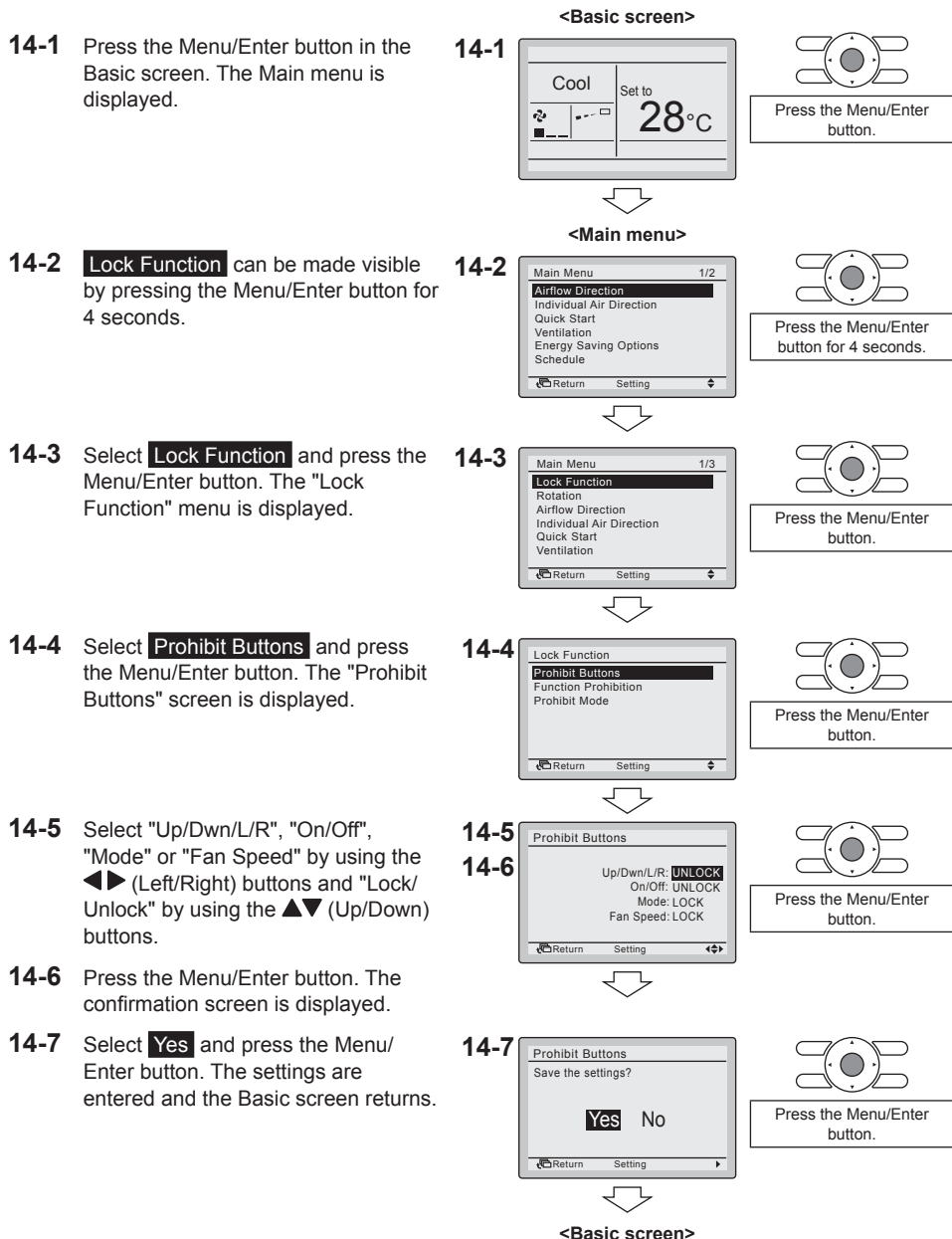

**14-8** To disable the Menu/Enter and Cancel button in the Basic screen, proceed as follow:

1. Keep the ► button pressed.
  2. Push the 3 indicated keys simultaneously (shortly) while keeping the ► button pressed.
- To enable the Menu/Enter and Cancel button in the Basic screen, follow the same procedure.

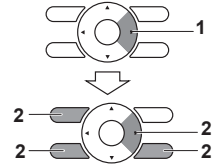

## NOTE

If you want to restrict the number of operable buttons on the sub remote controller, start with only connecting this controller to the unit. Make sure that this controller is set to "main" (factory default) first, change the restrictions to the setting you prefer and only then set the remote controller to "sub".

# 15. Function Prohibition

- Restriction of the number of operable functions.

**15-1** Press the Menu/Enter button in the Basic screen. The Main menu is displayed.

**15-1**

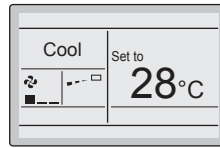

Press the Menu/Enter button.

<Main menu>

**15-2** **Lock Function** can be made visible by pressing the Menu/Enter button for 4 seconds.

**15-2**

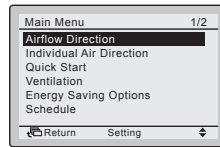

Press the Menu/Enter button for 4 seconds.

**15-3** Select **Lock Function** and press the Menu/Enter button. The "Lock Function" menu is displayed.

**15-3**

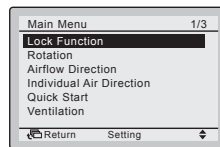

Press the Menu/Enter button.

**15-4** Select **Function Prohibition** and press the Menu/Enter button. The "Function Prohibition" screen is displayed.

**15-4**

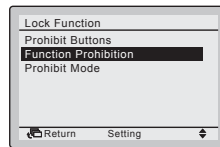

Press the Menu/Enter button.

**15-5** Select the desired function by using the ◀▶ (Left/Right) buttons and "Lock/Unlock" by using the ▲▼ (Up/Down) buttons.

**15-5**

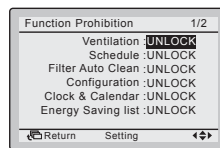

Press the Menu/Enter button.

**15-6** Press the Menu/Enter button. The confirmation screen is displayed.

**15-7**

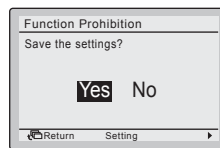

Press the Menu/Enter button.

<Basic screen>



**NOTE**

- If you want to restrict the number of operable functions on the sub remote controller, start with only connecting this controller to the unit. Make sure that this controller is set to "main" (factory set) first, change the restrictions to the setting you prefer and only then set the remote controller to "sub".
- When a function is prohibited, the  icon will be displayed next to the function.

## 16. Prohibit Mode

- Restriction of the number of operable modes.

**16-1** Press the Menu/Enter button in the Basic screen. The Main menu is displayed.

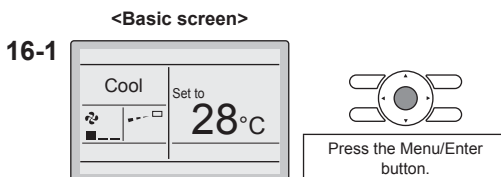

**16-2** **Lock Function** can be made visible by pressing the Menu/Enter button for 4 seconds.

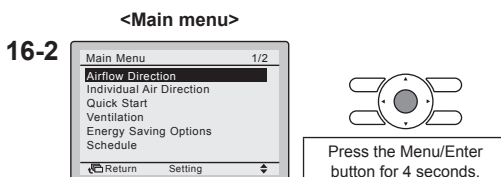

**16-3** Select **Lock Function** and press the Menu/Enter button. The "Lock Function" menu is displayed.

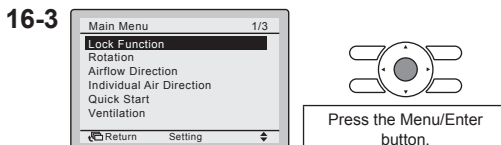

**16-4** Select **Prohibit Mode** and press the Menu/Enter button. The "Prohibit Mode" screen is displayed.

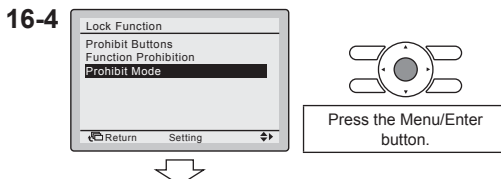

**16-5** Select “Fan”, “Cool”, “Heat”, “Auto”, “Dry” or “VentClean” by using the ◀ ▶ (Left/Right) buttons and “Enable/Disable” the selected mode by using the ▲▼ (Up/ Down) buttons.

**16-5**  
**16-6**

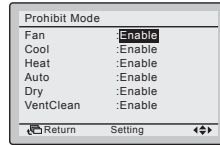

Press the Menu/Enter button.

**16-6** Press the Menu/Enter button. The confirmation screen is displayed.

**16-7** Select **Yes** and press the Menu/Enter button. The settings are confirmed and the Basic screen returns.

**16-7**

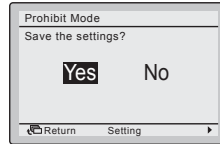

Press the Menu/Enter button.

<Basic screen>

## NOTE

- When the currently active mode is locked, this mode will still be active upon returning to the Basic screen. Only when the mode is changed, the disabled mode will not be available anymore. When all modes are locked, it is not possible to change to another mode other than the currently active mode.
- If you want to restrict the number of operable modes on the sub remote controller, start with only connecting this controller to the unit. Make sure that this controller is set to "main" (factory default) first, change the restrictions to the setting you prefer and only then set the remote controller to "sub".

# 17. Duty Rotation and Backup

The Rotation function is designed for units operating in critical applications (e.g. in server rooms that require lots of cooling). In this case, the system is equipped with an extra backup unit. Enabling Rotation then allows for:

- **Rotation:** because the system is equipped with more units than are required to provide the heating/cooling load, one of the units will remain inactive during normal operation. After a set time (i.e. "Rotation cycle time"), the inactive unit will start operating and a previously active unit will become inactive (i.e. duty rotation). Because the units are alternately allowed to take a break, the lifespan of the system increases.
- **Backup:** having a backup unit allows for additional system redundancy. If an active unit goes into error, Rotation makes sure the inactive one takes over.

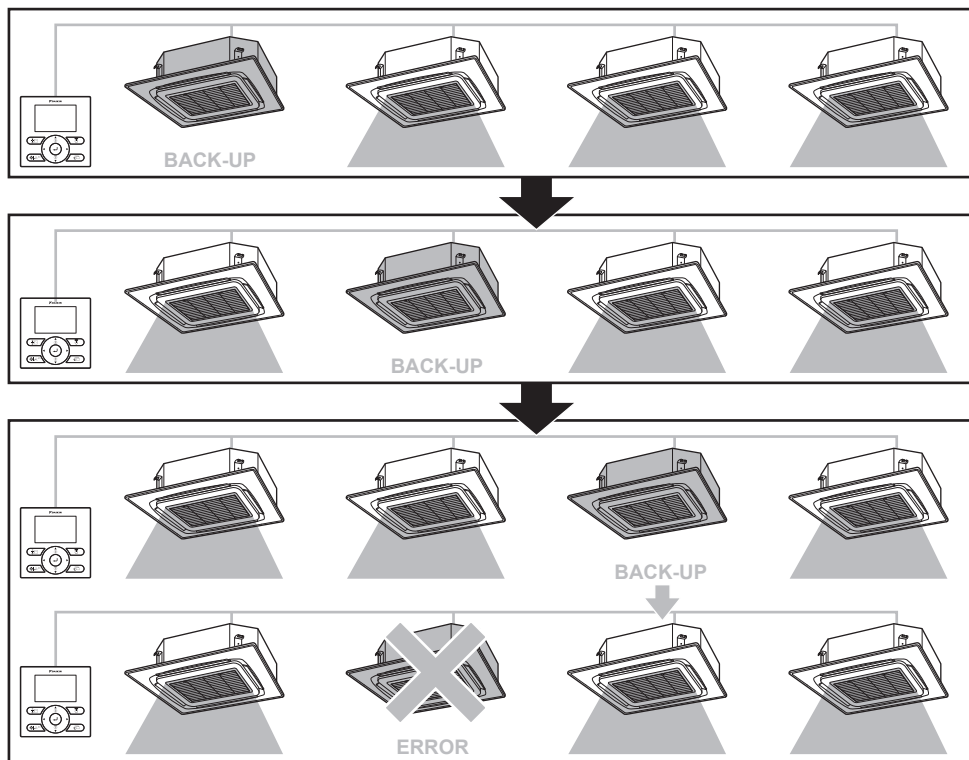



## NOTE

- To let the backup unit reach its cooling/heating capacity, an overlap period is included in which all units are active. (cfr. field setting 1E-7)
- The rotation order depends on the set Unit Number. For instructions on how to change the Unit Number, contact your local dealer.
- To be able to use the Rotation function, group control is required. For more information, see "22. Connection diagram"

**17-1** Press the Menu/Enter button in the Basic screen. The Main menu is displayed.

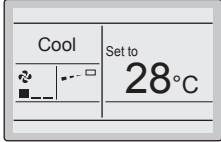

**17-1** **<Basic screen>**

Press the Menu/Enter button.

**17-2** **Rotation** can be made visible by pressing the Menu/Enter button for 4 seconds.

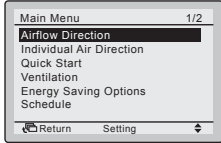

**17-2** **<Main menu>**

Press the Menu/Enter button for 4 seconds.

**17-3** Select **Rotation** and press the Menu/Enter button. The "Rotation" menu is displayed.

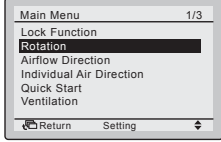

**17-3**

Press the Menu/Enter button.

**17-4** Select **Rotation Cycle Time Setting** and press the Menu/Enter button. The "Rotation" screen is displayed.

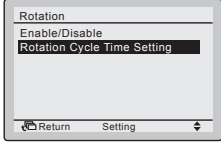

**17-4**

Press the Menu/Enter button.

**17-5** Select the desired rotation cycle time by using the ▲▼ (Up/ Down) buttons.

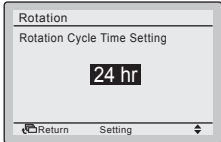

**17-5**

Change the rotation cycle time by using the ▲▼ (Up/ Down) buttons.

**17-6** Press the Menu/Enter button. The confirmation screen is displayed.

**17-6**

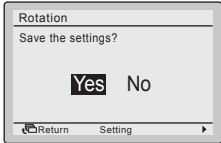



**17-7** Select **Yes** and press the Menu/Enter button. The settings are entered and the Basic screen returns.

Press the Menu/Enter button.

**<Basic screen>**

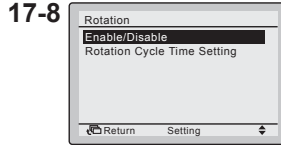
**17-8** To enable/disable Rotation, go to the "Rotation" menu and select **Enable/Disable**



Press the Menu/Enter button.

**17-9** Press the ▲▼ (Up/ Down) buttons to select **Enable** or **Disable**. The confirmation screen will appear when the Menu/Enter button is pressed.

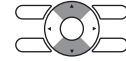
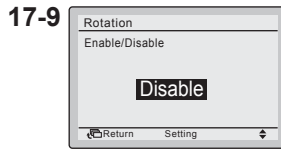

Change the setting by using the ▲▼ (Up/Down) buttons.

**17-10** Select **Yes** and press the Menu/ Enter button. The function is enabled/disabled and the Basic screen returns.

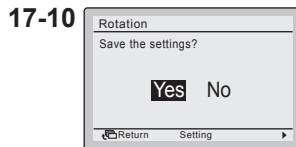

Press the Menu/Enter button.

<Basic screen>

## NOTE

- After saving changes to the settings, Rotation is automatically enabled.

# 18. External Input Interlock Function

## NOTE

- Only available when the optional BRP7A5\* Digital Input Adapter is connected.
- In case there are communication problems or the adapter is not working correctly, the External Input Interlock menu will not be visible in the Service Settings menu.
- When a second remote controller is connected, it is not possible to use the BRP7A5\* Digital Input Adapter.
- When a BRP7A5\* Digital Input Adapter is connected, the schedule function will be disabled as long as the BRP7A5\* Digital Input Adapter is connected.  
For more information about the schedule functionality, refer to the operation manual.
- When a centralized controller is connected, the External Input Interlock function can be overruled by the centralized controller. The centralized controller has priority and works like there was no BRP7A5\* Digital Input Adapter connected.

- Please make sure that the BRP7A5\* Digital Input Adapter and the optional contacts (window contact and key card contact) are correctly installed. Don't forget to confirm that the "No Volt" contact on the BRP7A5\* Digital Input Adapter PCB is in the correct position.
- For installation and connection of the BRP7A5\* Digital Input Adapter refer to the corresponding installation manual.

**18-1** Press and hold the Cancel button for 4 seconds or longer. The Service Settings menu is displayed.

**<Basic screen>**

**18-1**

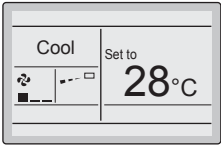





Press and hold the Cancel button for 4 seconds or longer while the backlight is lit.

**18-2** Select **External Input Interlock** and press the Menu/Enter button. The "External Input Interlock " screen is displayed.

**<Service Settings>**

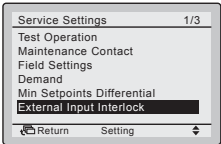
**18-2**





Press the Menu/Enter button.

**18-3** Select “B2 Delay Timer”, “B2 Reset Timer”, “Reset On/Off”, “Reset Mode”, “Reset Cool SP” or “Reset Heat SP” by using the ◀▶ (Left/Right) buttons and change the settings by using the ▲▼ (Up/ Down) buttons.

**18-3**  
**18-4**

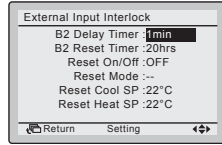

Press the Menu/Enter button.

**18-4** Press the Menu/Enter button. The confirmation screen is displayed.

**18-5** Select **Yes** and press the Menu/Enter button. The settings are entered and the Service Settings menu returns.

**18-5**

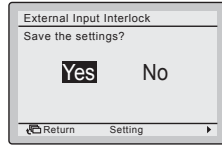

Press the Menu/Enter button.

<Service Settings>

Parameter	Explanation	Possible values	Default value
<b>B2 Delay Timer</b>	Timer that starts after removing the Key Card. As long as this timer does not expire, the unit continues to operate normally.	0 - 10 minutes	“1 min”
<b>B2 Reset Timer</b>	Timer that starts when Delay Timer has expired. When this timer expires, the previous state changes to the “Default Reset Setting” state.	0 – 20 hours	“20 hrs”
<b>Reset On/Off</b>	“Default Reset Setting” On/Off state.	“ON”, “OFF”, “--”	“OFF”
<b>Reset Mode</b>	“Default Reset Setting” operation mode.	“Auto”, “Cool”, “Heat”, “Fan”, “--”	“--”
<b>Reset Cool SP</b>	“Default Reset Setting” cooling setpoint.	See indoor unit’s setpoint range and setpoint range limitation, “--”.	“22°C”
<b>Reset Heat SP</b>	“Default Reset Setting” heating setpoint.	See indoor unit’s setpoint range and setpoint range limitation, “--”.	“22°C”

**NOTE**

- When a parameter is “--”, this means that nothing will be changed for this parameter and the current active value is kept.

Window contact logic:

Window contact B1	Key Card contact B2	Time	Action
Closed	Closed	/	<ul style="list-style-type: none"> <li>The unit is operating normally.</li> <li>The unit returns to the previous state before opening the contact.</li> </ul>
Open	Closed	/	The unit is forced off (operation off): <ul style="list-style-type: none"> <li>No delay and reset timer functionality.</li> <li>No setback functionality.</li> <li>Not possible to turn the unit ON with the On/Off button.</li> </ul>

Key Card contact logic:

Window contact B1	Key Card contact B2	Time	Action
Closed	Closed	<ul style="list-style-type: none"> <li>/</li> <li>Delay timer &lt; Time &lt; Reset timer</li> <li>Time &gt; Reset timer</li> </ul>	<ul style="list-style-type: none"> <li>The unit is operating normally.</li> <li>The unit returns to the previous state before opening the contact if the reset timer has not expired.</li> <li>The unit returns to the "Default Reset Setting" state (menu setting) if the reset timer has expired.</li> </ul>
Closed	Open	Time < Delay timer	The unit is operating normally.
Closed	Open	Time > Delay timer	The unit is forced off (operation off): <ul style="list-style-type: none"> <li>Depending on whether the setback functionality is enabled, setback will work or not.</li> <li>Not possible to turn the unit ON with the On/Off button.</li> <li>The Reset timer starts counting after the Delay timer has expired.</li> </ul>

**NOTE**

- The previous state consists of On/Off state, Operation mode, cooling and heating setpoint.
- The fan speed and the setback cooling and heating setpoint can be changed at any time without losing the changes when using the contacts.
- The fan speed is stored for the two main operation modes independantly. Heating only has its own saved fan speed and Cooling only, Dry and Fan only have their own fan speed.
- Changes made while the Key Card contact is open and the delay timer has not expired (normal operation) are not saved when closing the contact again.



Combination of window and key card contact logic:

- The window contact has priority over the delay timer and the setback functionality of the key card contact:  
When the window contact is opened while the key card contact is open, the delay timer will immediately expire if it is still running and setback will not work anymore. The reset timer will immediately start counting or will not reset when it was already running.
- The reset timer functionality of the key card contact has priority over the window contact when returning to the previous state:  
When the key card contact is opened while the window contact is open, the delay timer will start running. When the delay timer expires the reset timer will start running. When the reset timer expires, the previous state is updated to the "Default Reset Setting" state.

### Example 1 (See "Example 1" on page 41)

- a) Remove the key card, the unit continues to work normally until the delay timer has expired.
- b) Open the window before delay timer expires, the unit stops immediately. It is not possible to turn the unit on or off, the setback functionality does not work, the delay timer stops counting and the reset timer starts counting.
- c) Insert the key card, only an update of the previous state happens. The unit is forced off and the setback functionality is still disabled (see window contact logic):
  - If the reset timer has not expired before inserting the key card, the previous state is the same as the original state because there was only a change to the forced off state.
  - If the reset timer has expired before inserting the key card, the previous state is the "Default Reset Setting" state.
- d) Close the window, the unit reverts to the previous state. The previous state is depending on the expiration of the reset timer.

### Example 2 (See "Example 2" on page 42)

- a) Open the window, the unit stops immediately. The unit cannot be turned on with the On/Off button, the setback functionality does not work and the delay timer does not start counting.
- b) Remove the key card. The delay timer starts counting.
- c) Close the window. The state is the same as if the window was never opened (setback will work if enabled).
  - If the delay timer expires before closing the window, the reset timer starts counting. Closing the window has no influence on the reset timer.
  - If the delay timer has not expired before closing the window, the delay timer will expire immediately and the reset timer starts counting.
- d) When the reset timer expires, the previous state is updated to the "Default Reset Setting" state.
- e) Insert key card.
  - If the reset timer has not expired before inserting the key card, the unit returns to the state before the window was opened (last on state).
  - If the reset timer has expired before inserting the key card, the unit goes to the "Default Reset Setting" state.

# Example 1

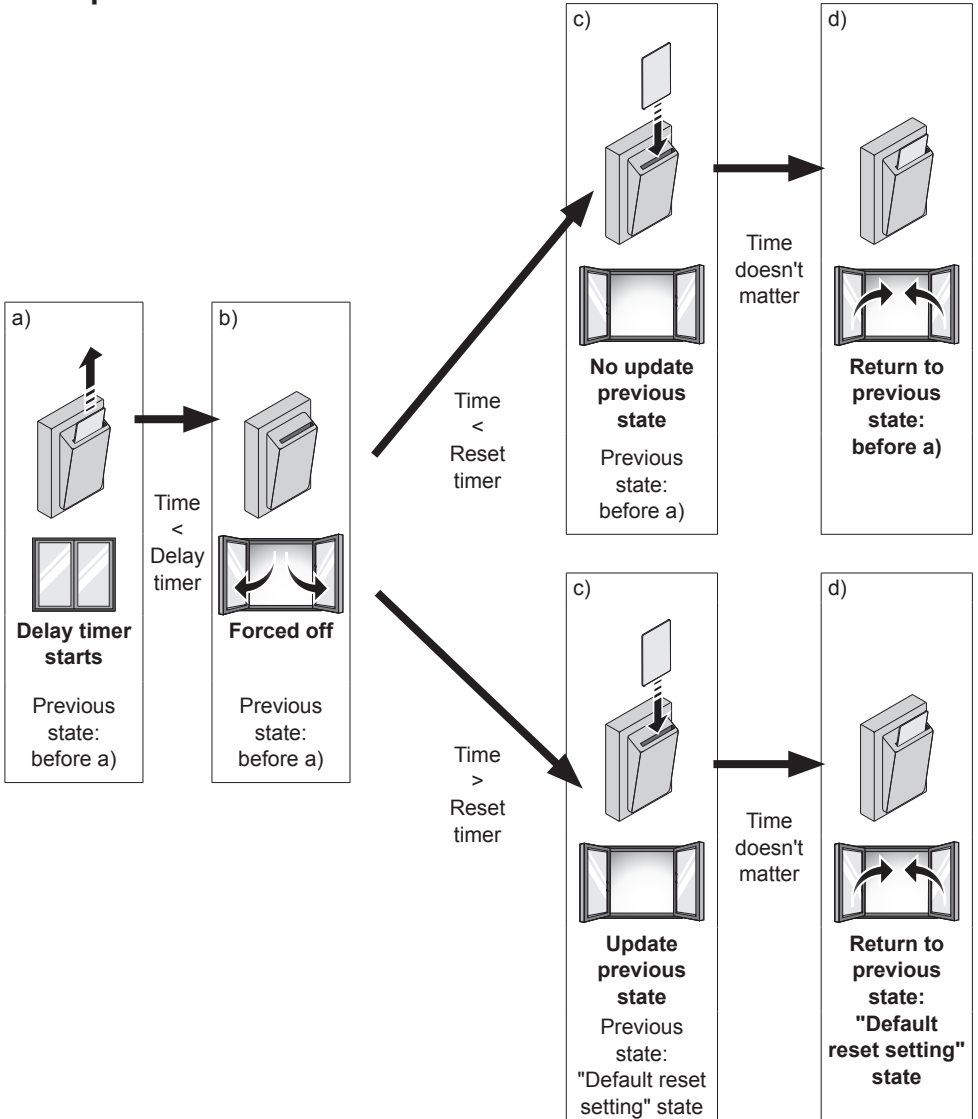

## Example 2

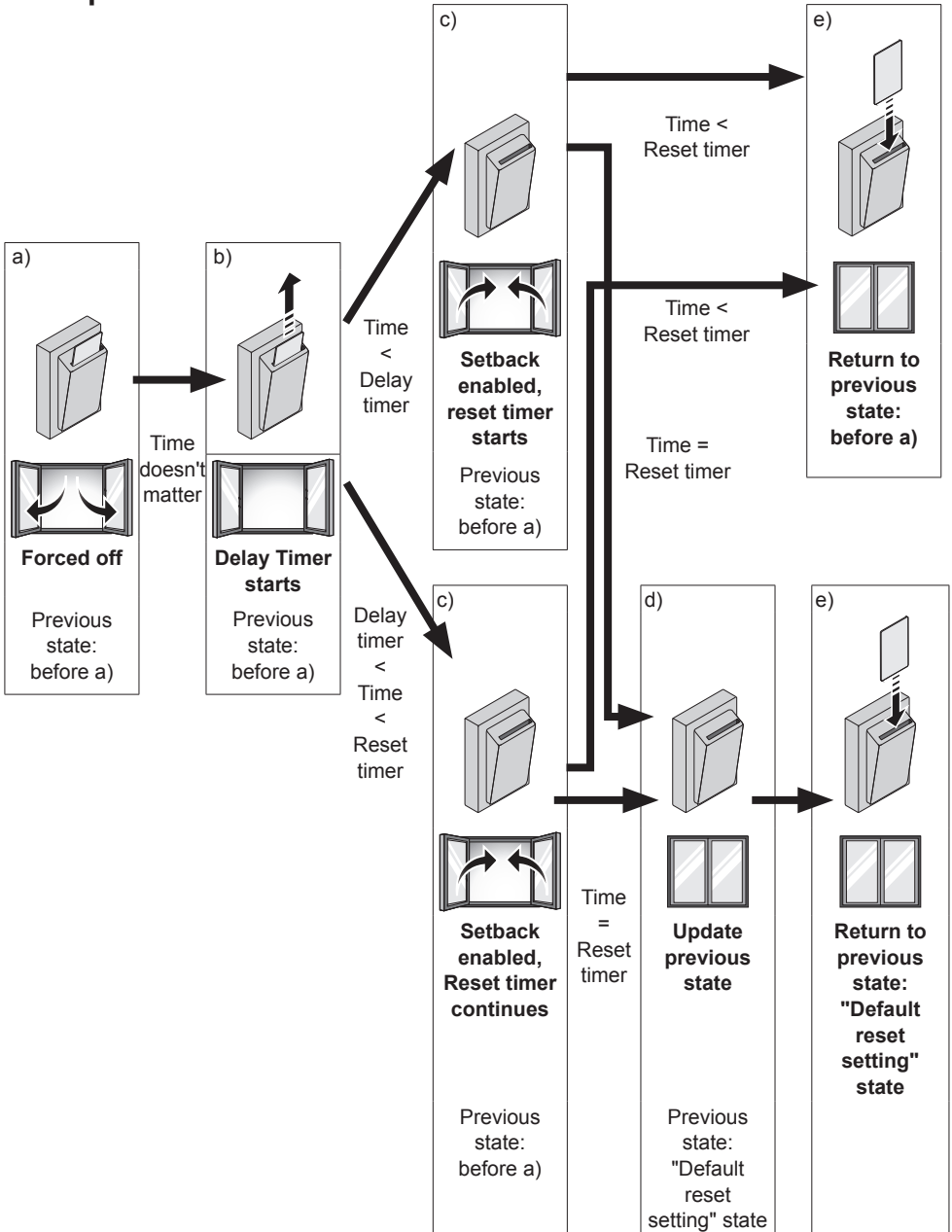

# 19. Single and Dual setpoint mode

## NOTE

- When a centralized controller is connected, the remote controller is forced to single setpoint mode. It is not possible to change to dual setpoint mode.

- Switch between Single setpoint mode and Dual setpoint mode
- Single setpoint mode is set by selecting “Single SP”
- Dual setpoint mode is set by selecting “0°C” – “8°C”

**19-1** Press and hold the Cancel button for 4 seconds or longer. The Service Settings menu is displayed.

**19-1**

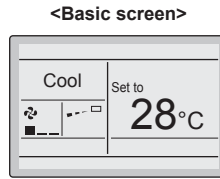

Press and hold the Cancel button for 4 seconds or longer while the backlight is lit.

**19-2** Select **Min Setpoints Differential** and press the Menu/Enter button. The "Min Setpoints Differential" screen is displayed.

**19-2**

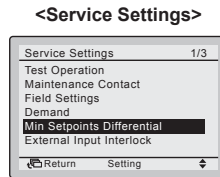

Press the Menu/Enter button.

**19-3** Select “None”, “Single Sp” or “0°C” – “8°C” by using the ▲▼ (Up/Down) buttons.

**19-3**

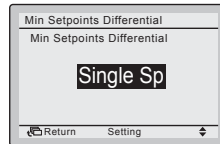

Press the Menu/Enter button.

**19-4** Press the Menu/Enter button. The confirmation screen is displayed.

**19-5** Select **Yes** and press the Menu/Enter button. The settings are confirmed and the Service Settings menu returns.

**19-5**

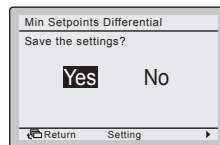

Press the Menu/Enter button.

**19-6** Press the Cancel button once. The remote controller restarts and the Basic screen returns.

<Service Settings>

**NOTE**

- In Single setpoint mode both cooling and heating setpoints are the same. Changing one setpoint automatically changes the other setpoint.
- In Dual setpoint mode there is always a limitation for the heating and cooling setpoint:
  - Cooling setpoint  $\geq$  heating setpoint + minimum setpoints differential.  
When the cooling setpoint is lowered below the heating setpoint + minimum setpoints differential, the heating setpoint is automatically lowered.
  - Heating setpoint  $\leq$  cooling setpoint – minimum setpoints differential.  
When the heating setpoint is increased above the cooling setpoint – minimum setpoints differential, the cooling setpoint is automatically increased.

## 20. Other Service Settings

### 20-1 Group Address

- Assign the group address and unit number for centralized control.
- The group and unit address can only be set when a centralized controller is connected. This menu is only visible when a centralized controller is connected.
- The group and unit address can be "set" and "released".

**NOTE**

Don't forget to release the group address before disconnecting the centralized controller because the menu will not be accessible afterwards.

### 20-2 Indoor and outdoor unit Airnet Address

- Set the indoor and outdoor unit Airnet Address.

### 20-3 Indoor Unit Status

- Consult the indoor unit thermistor temperatures.

	SkyAir	VRV
Th1	Suction air thermistor	Suction air thermistor
Th2	Heat exchanger thermistor	Heat exchanger liquid pipe thermistor
Th3	-	Heat exchanger gas pipethermistor
Th4	Discharge air thermistor	Discharge air thermistor
Th5	-	-
Th6	-	-

## 20-4 Outdoor Unit Status

- Consult the outdoor unit thermistor temperatures.

	SkyAir	VRV
Th1	Outdoor air thermistor	-
Th2	Heat exchanger thermistor	-
Th3	Discharge pipe thermistor	-
Th4	-	-
Th5	-	-
Th6	-	-

## 20-5 Forced Fan ON

- Force the fan(s) ON for the individual indoor units.
- This function can be used to check which indoor unit number is associated with which indoor unit.

## 20-6 Switch Main Sub Controller

- Swap the main and sub remote controller designation.

### NOTE

- Changing the main/sub designation requires to turn the power OFF and ON again.

## 20-7 Filter Indicator

- Resets the timer of the filter indicator for all indoor units.

## 20-8 Test Filter Auto Clean

- Test if filter auto clean works.
- This function is only available if the Self Cleaning Decoration Panel is installed.
- When Filter Auto Clean is disabled (Disable Filter Auto Clean), the message "Auto filter clean is disabled" will be shown when opening the Test Filter Auto Clean screen.

## 20-9 Brush/Filter Ind

- Resets the timer of the filter indicator for all indoor units.
- This function is only available if the Self Cleaning Decoration Panel is installed.

## 20-10 Disable Filter Auto Clean

- Enable/disable the use of the Filter Auto Clean function.
- When disabled, the message "Auto filter clean is disabled" will be shown when opening the Test Filter Auto Clean and Filter Auto Clean screen.
- This function is only available if the Self Cleaning Decoration Panel is installed.

# 21. Software update with Updater

- The languages that the controller supports vary by controller model.
- Other language packages can be installed with the "PC USB cable" option (EKPCAB3) + updater software.
- Prerequisites:
  - Updater software: please contact your local dealer for the correct version.
  - "PC USB cable" EKPCAB3 or higher: includes wire harness and cables 4P344073-1- and 4PW64322-1A (both are needed during the installation).

## Installation instructions:

1. Make sure that the indoor unit is powered off.
2. Connect the cables.  
See the figure below for how to connect the cables.
3. Power on the indoor unit.
4. Start the updater on the PC.
5. Proceed to the "Update Procedure Selection" window. The remote controller software is automatically detected.
6. Fill in the model name "BRC" in the filter box and select the desired language pack.
7. Follow the onscreen instructions (additionally, during installation, cable 4P344073-1 is needed).

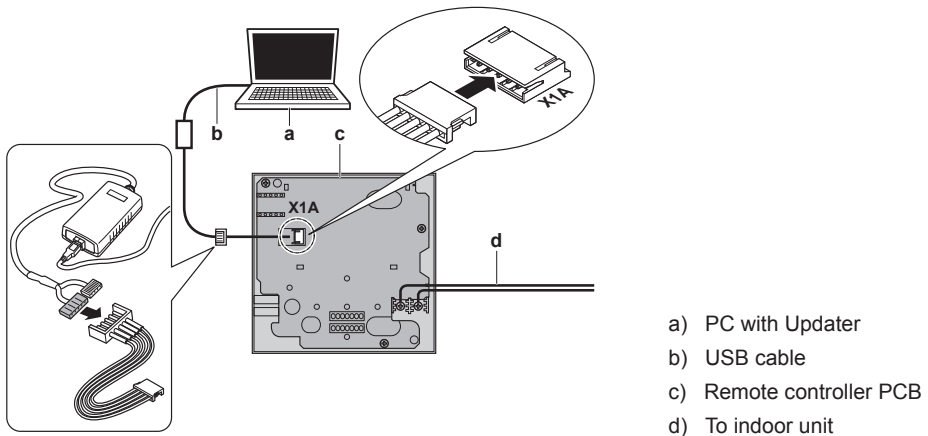

More information about the available languages can be found in ["13. Language" on page 28](#).

## 22. Connection diagram

### 22-1 Typical layout

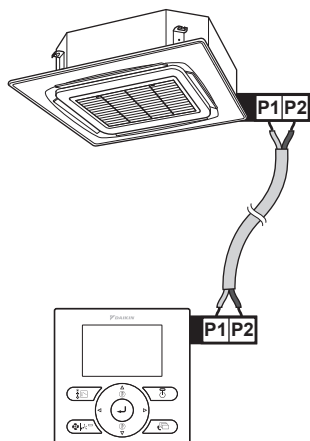

### 22-2 Typical layout for group control

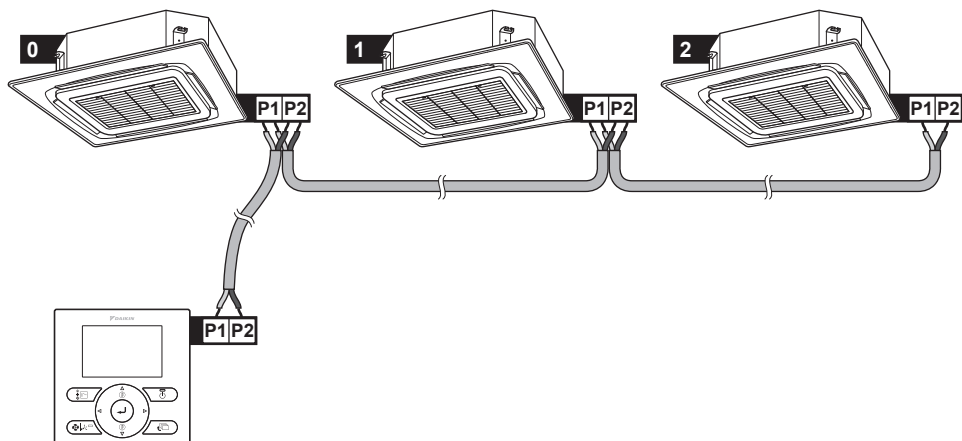

#### NOTE

- To be able to enable the Rotation function, group control is required.
- When using group control, every unit is automatically assigned an address (i.e. Unit Number). In case the Rotation function is enabled, this number determines the rotation order. For instructions on how to change the Unit Number, contact your dealer.



### 22-3 Group control: main controller + sub controller

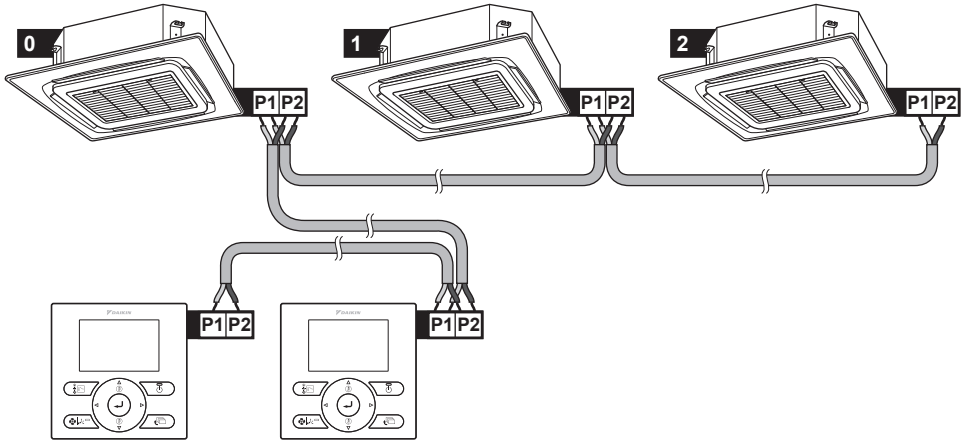

### 22-4 Group control: controller + digital inputs adapter BRP7A5\*

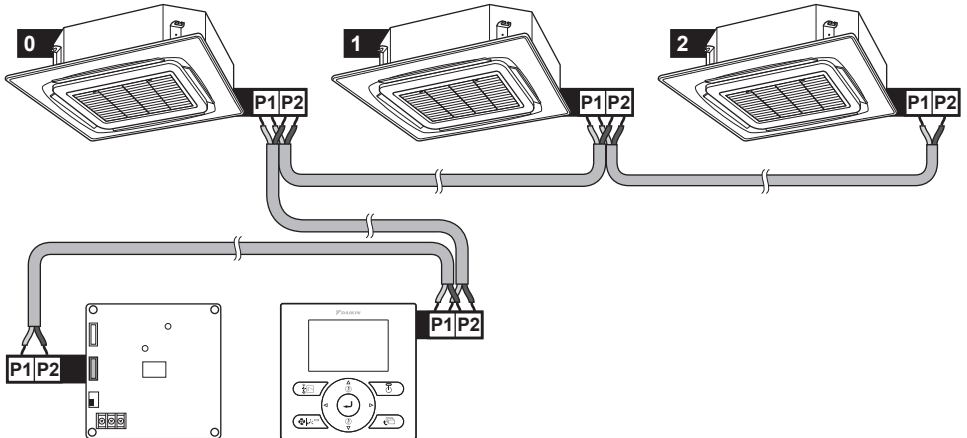

## 22-5 Controller + DIII central control equipment

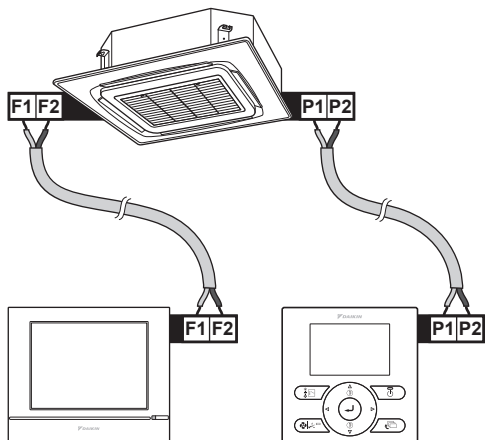

### NOTE

If the controller is used together with DIII central control equipment, then ...

- ... the schedule timer function can be restricted.
- ... do not enable setback mode.

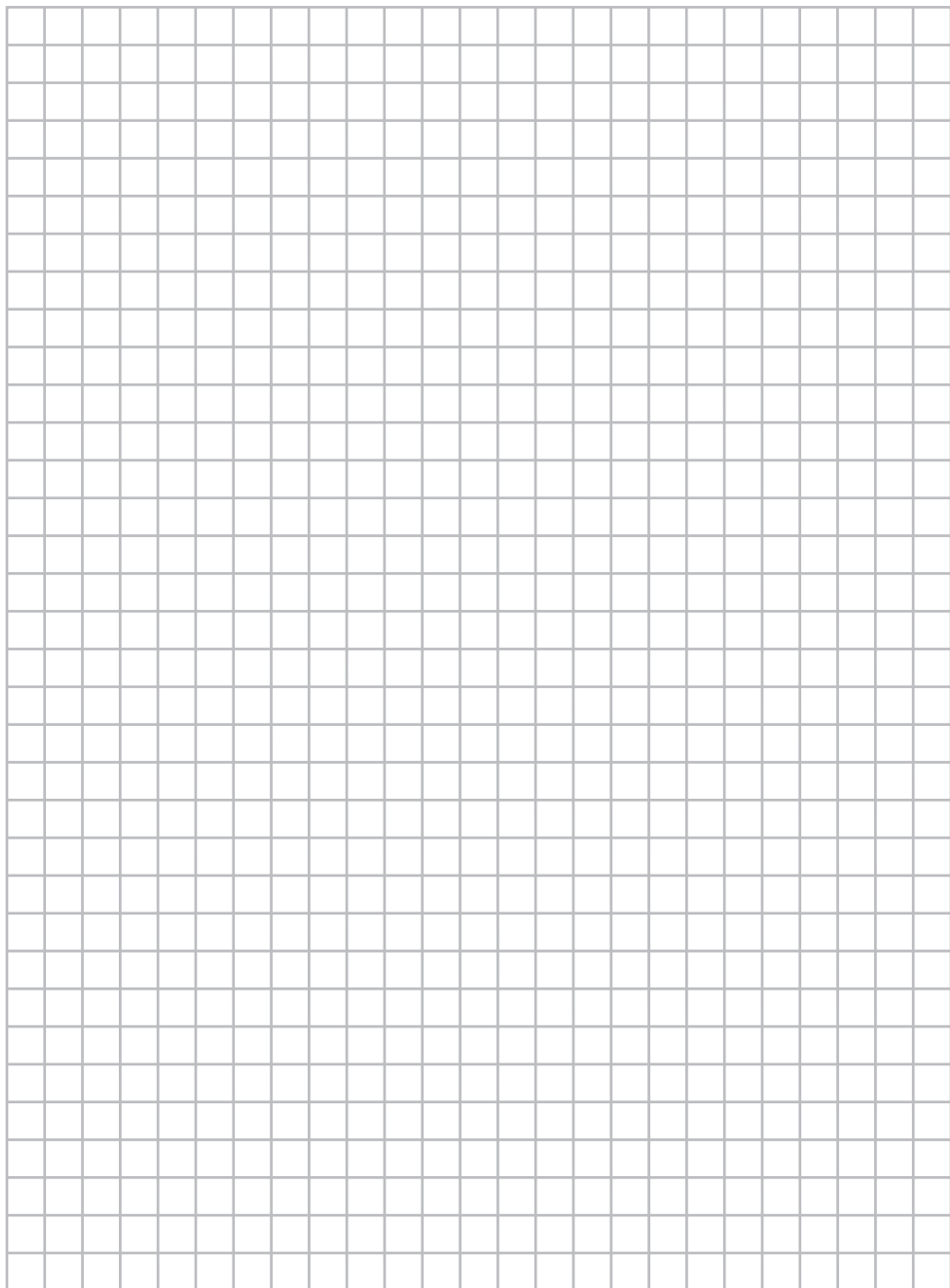

**DAIKIN EUROPE N.V.**

Zandvoordestraat 300, B-8400 Oostende, Belgium

4P419250-1 2015.10

Copyright 2015 Daikin